

**Raychem**

# Handbook for **comfortable warm floors**

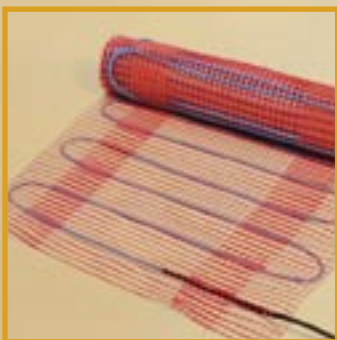
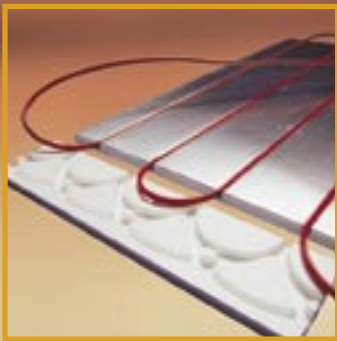

**tyco**  
Thermal Controls

# About this handbook

We all know, that when our feet are cold, our whole body feels cold... Smart underfloor heating is the answer.

Put those woolen socks away, your children can play comfortably on the floor... even the cat will be grateful!

This handbook shows how to choose the right underfloor heating system, gives you information about the installation and many smart tips.

**SMART TIP**

The Smart Tip provides you with extra information.



If you have already selected the right system go to page 30 to draw your project and request **a free design.**

**Raychem**



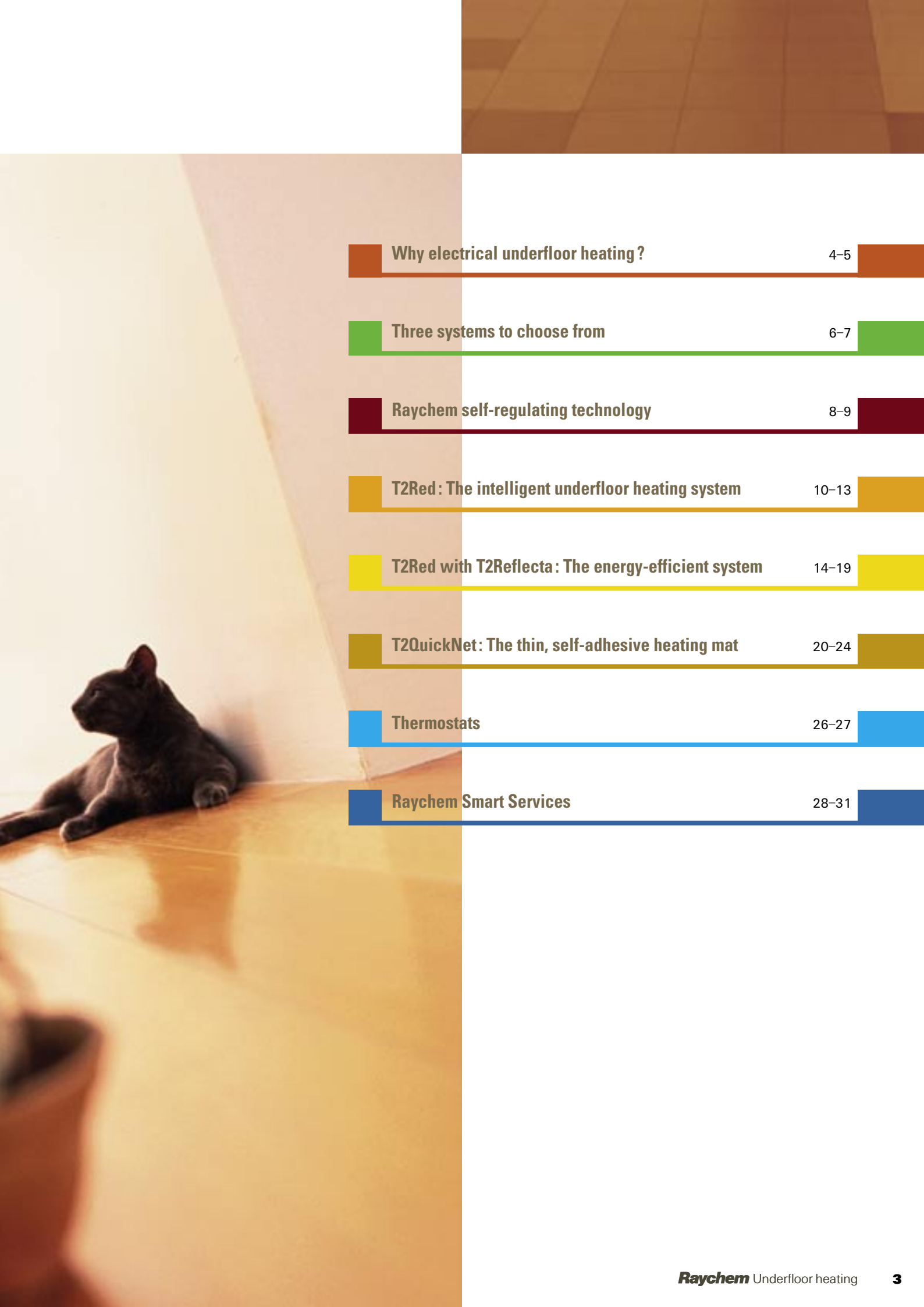

<b>Why electrical underfloor heating?</b>	4-5
<b>Three systems to choose from</b>	6-7
<b>Raychem self-regulating technology</b>	8-9
<b>T2Red : The intelligent underfloor heating system</b>	10-13
<b>T2Red with T2Reflecta : The energy-efficient system</b>	14-19
<b>T2QuickNet: The thin, self-adhesive heating mat</b>	20-24
<b>Thermostats</b>	26-27
<b>Raychem Smart Services</b>	28-31

# Why electrical underfloor heating?

Comfort is everything, especially in the home. With Raychem's smart electrical underfloor heating, you can offer a beautiful warm floor, hassle free to your customers!

## Increased comfort whilst saving on heating costs

### Underfloor heating brings great comfort and helps to save on heating costs!

Electric underfloor heating is installed close to the floor surface resulting in a quick warm up of the room. Thanks to the uniform heat distribution across the floor, it is possible to set the thermostat 2 degrees lower than usual, without any loss of comfort or warmth.

It is an excellent system to provide complete room heating or to compliment the existing heating system.

During spring or autumn, you can turn off the conventional heating, and keep your floors warm, comfortable, and cozy. The dog will confirm this!

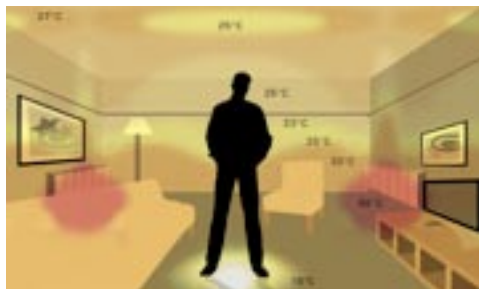

Heat radiation from a conventional heating system with radiators. Large temperature variations (18–65°C) in the room.

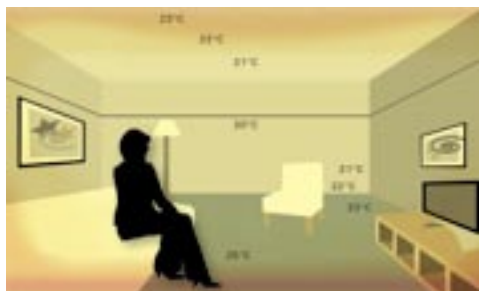

Heat radiation from an underfloor heating system. Small temperature variations (20–25°C) and heat where you need it.

## Healthy and safe heating

### Dry floors: more hygienic and easier to clean

Electrical underfloor heating causes less air movement, hence less dust. Another advantage can be found in the bathroom or wet rooms. Wet floors will dry much faster, rugs in the bathroom will as well and there will be less risk of mildew or mites.

A dry floor is also easier to keep clean as the dust doesn't "stick" to the floor.

### Negligible electro-magnetic fields

Household appliances and home electronics can produce electro-magnetic fields. Raychem products emit the lowest possible electro-magnetic fields thanks to the twin wire construction.

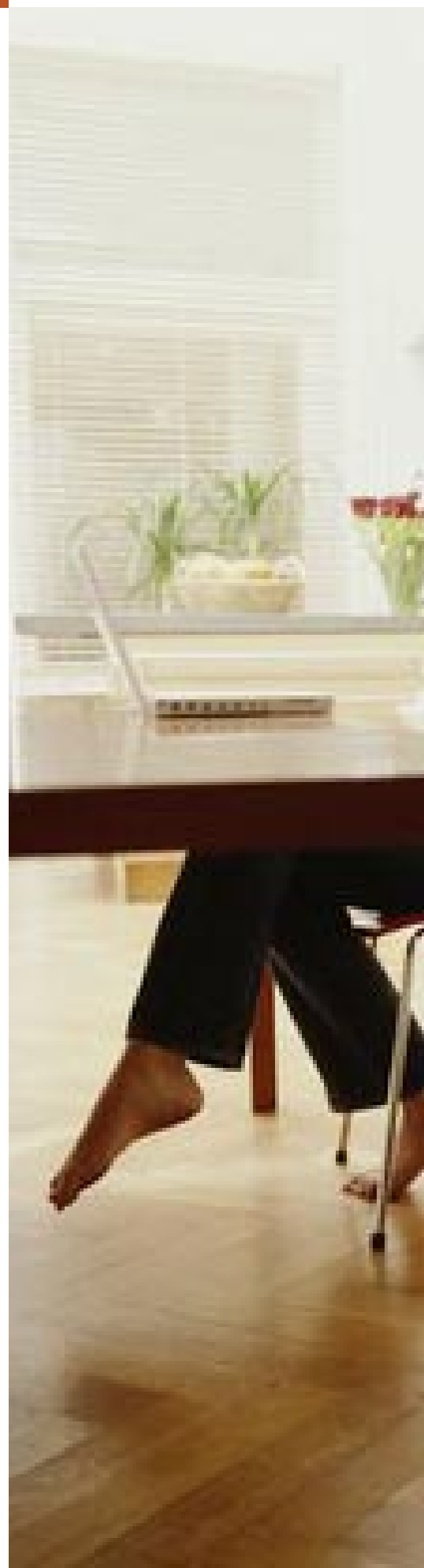



## Easy-to-install and suited for all floor types

Smart underfloor heating can be installed under any floor. It does not take up any space in your living area, giving the freedom to position furniture freely.

At home or in the office, in the bathroom or in the living area, Raychem smart underfloor heating systems provide a warm floor and a pleasant room temperature. Our various systems can be installed under all floor coverings like tiles, marble, wood, laminate or carpet.

## Easy and hassle free

Raychem systems can be fitted directly on the existing floor (wood, plaster, concrete). Avoiding unnecessary dust, dirt or noise!

The T2QuickNet mat, is only 3 mm thick, so floor height gain is not a problem. Even the self-regulating system T2Red and T2Reflecta is a mere 13 mm thick.

Ask your local supplier which system is most appropriate for you.



### 5 good reasons to choose Raychem smart underfloor heating

- 1 Comfortable and safe.
- 2 Hassle free installation and maintenance free.
- 3 Energy-efficient and cost saving.
- 4 Can be installed under all floor coverings.
- 5 Triple warranty.

# Three systems to choose from

There is a Raychem smart underfloor heating solution for every situation: renovation and new construction.

## Triple warranty: the reassurance of a trustworthy brand

Raychem underfloor heating systems are known for their long life and quality.

The heating cables are made from quality polymers for increased durability.

We offer a 12-year warranty on our heating systems. In case of a product failure we repair the damaged heating cable or offer you a new product.



**CSTB**



**POLYCERT**



Our products satisfy the requirements of the relevant European Directives



Member of the European Radiant Floor Heating Association e.v.

## 1 T2Red

### The intelligent underfloor heating system

The T2Red self-regulating system senses other heat sources such as solar radiation, electrical appliances and lighting and it automatically **adjusts its heat output** accordingly. More heat is produced in colder areas –such as near windows or doors- and less heat is produced in warmer areas –such as under rugs and furniture.

There is **no risk of overheating** which gives unlimited flexibility for moving furniture around.



It can be **installed on all subfloors** (plastic, concrete, wood) -in dry or wet areas- and it can be easily adapted to all room sizes and shapes.

Info → page 10–13

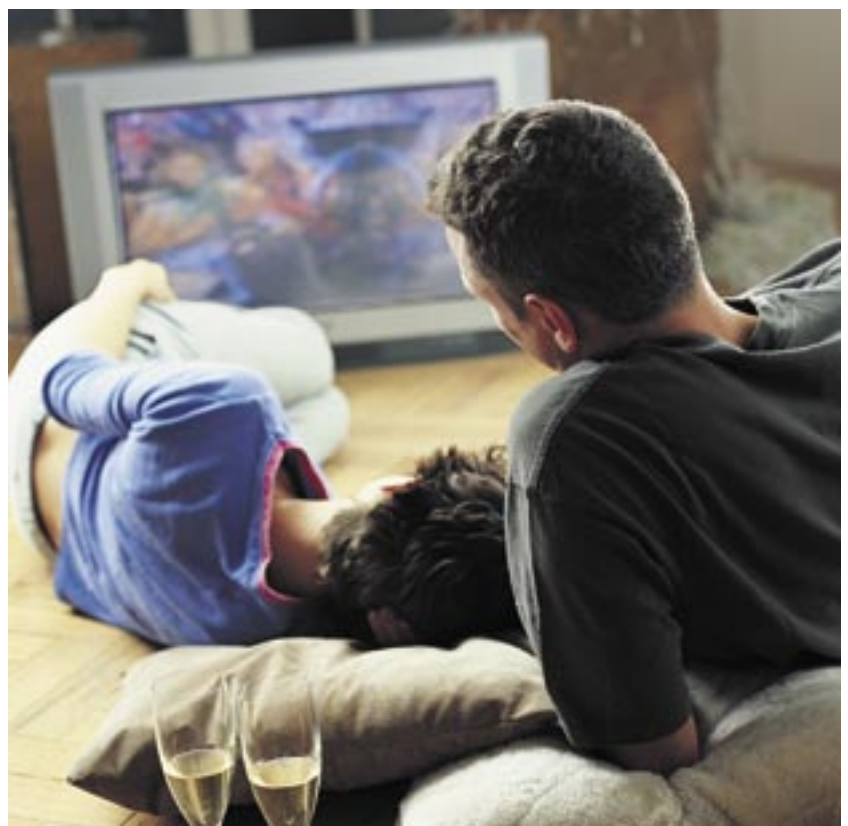

# Make your choice ...

## 2 T2Red with T2Reflecta

### The energy-saving underfloor heating system

This system combines the self-regulating T2Red heating cable with T2Reflecta, the pre-grooved, thermally insulated, aluminium-covered plate.

It provides extra **energy savings of 20% or more**. The thermal insulation and aluminium plates reduce heat losses and provide an even heat distribution.

The T2Red with T2Reflecta system is the first choice for wooden or laminate floors. It can be adapted to **all room sizes** and it can **be installed on most subfloors**.

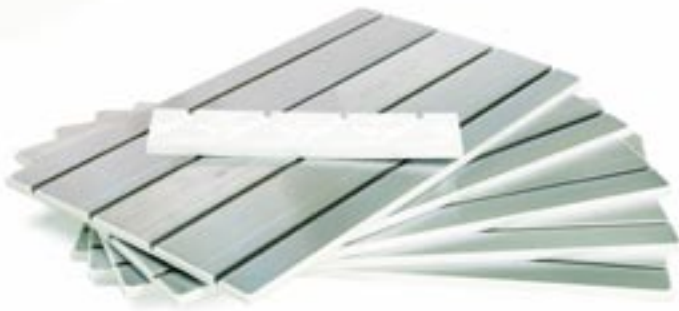

Info → page 14–19

## 3 T2QuickNet

### The thin, self-adhesive heating mat



The thin T2QuickNet mat is the ideal solution for renovation – especially for tile floors. The ultra-thin (3 mm) mat is laid directly in the filler or adhesive.

It can be installed on all subfloors\* which are sufficiently insulated and conforming to applicable building regulations.

T2QuickNet exists in two versions: T2QuickNet 90 can be used on all solid subfloors and T2QuickNet 160 when more output and a faster heat up time is required.

Info → page 20–24

### A system for every top floor

	Floor covering						
	Tiles	Natural stone	Laminate	Wood	Linoleum	Plastic floor covering	Textile floor coverings**
T2Red in filler	☺☺☺	☺☺☺	☺☺☺	☺☺☺	☺☺	☺☺	☺☺
T2Red with T2Reflecta	☺☺☺	☺☺☺	☺☺☺	☺☺☺	☺☺☺	–	–
T2QuickNet*	☺☺☺	☺☺☺	☺	☺	☺	☺	☺

☺☺☺ Very good • ☺☺ Good • ☺ Contact Tyco Thermal Controls 0800 969 013

\* T2QuickNet 160 not on wooden subfloors.

\*\* must be suitable for underfloor heating (maximum resistance to heat transfer 0,15 W/m²K)

# Raychem

## Self-regulating technology

### What does self-regulating mean?

Many years ago, Raychem developed self-regulating heating cables. They automatically adjust their power output to compensate for temperature changes.

The outer jacket, braid and inner jacket provide mechanical, chemical and electrical protection... but the magic happens in the

conductive core. The conductive core is extruded over the two, parallel conductors.

As the ambient temperature drops **1**, the core contracts microscopically and the number of electrical paths through the core increases. More heat is produced.

Conversely, as the ambient temperature rises **2**, the core expands and has fewer electrical paths. Less heat is produced.

A self-regulating heating cable adjusts its power output along its entire length. That's what makes it a safe and reliable solution for many applications.

### The advantages of a self-regulating underfloor heating system.

#### 1. Safety and reliability



- Avoids overheating.
- The cable can be closely spaced.
- Maintenance-free.

#### 2. Easy installation



- The cable can be cut-to-length (e.g. when it needs to be adjusted to complex room shapes).
- The cable can be installed directly on the existing subfloor.

#### 3. Energy efficiency



- By adjusting its output to the room temperature, the energy consumption is reduced to a minimum.



In colder areas, (e.g. near doors or windows), more heat is produced.

In warm areas, (e.g. in the middle of the room or under carpets and furniture), less heat is produced.

### Power output

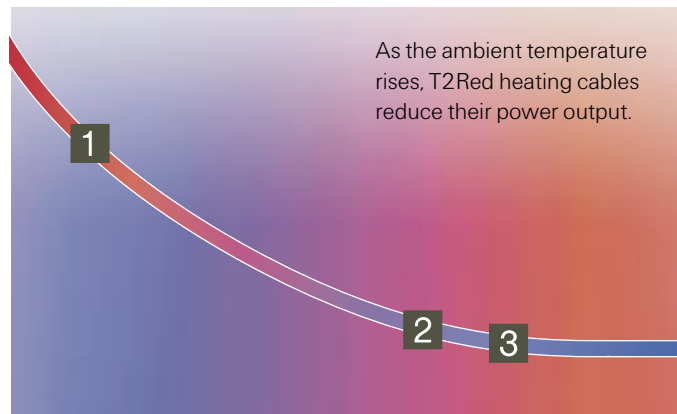

As the ambient temperature rises, T2Red heating cables reduce their power output.

Ambient temperature



# A unique technology for more comfort and safety



## Near the door there is a cold draught

- The cable senses the need for more heat. and increases its heat output.



## During the day, the sun heats the floor next to the window.

- The cable will lower its heat output automatically.
- No risk of overheating.



## Under the carpet, there is less need for heat.

- The cable will sense this and lower its heat output accordingly.
- There is no risk of overheating or damage to the floor.

# T2Red: The intelligent underfloor heating system

## 1 T2Red



T2Red is a self-regulating underfloor heating cable for reduced height installation. The cable can be installed under any type of floor surfaces without a risk of overheating. The intelligent heating cable is ideal for improved living comfort in the entire house, from bathroom to children's room.

- **Easy-to-design:** one heating cable for all shapes of rooms.
- **Flexible:** cut-to-length, no cold lead needed.
- **Ideal for renovation:** reduced height (max. 8 mm).

### Applications

Living rooms, kitchens, bathrooms, dining rooms, children's room, conservatories:

- **Top floor:** Tiles, parquet, natural stone, laminate, carpet\*.
- **Subfloor:** Cement screed; anhydrite screed, wooden floor, Gypsum board, timber floor board, asphalt screed.

\*must be suitable for underfloor heating (maximum resistance to heat transfer 0,15 W/m<sup>2</sup>K)

### Embedding options

Height	T2Red
0 – 3 mm	☺☺
until 15 mm	☺☺☺
15 mm until 50 mm	☺☺

## Renovation

The requirements for renovation are specific due to:

- Less construction height.
- Poor flooring insulation.
- Unevenness of the floor.
- Many different types of subfloor (cement screed, anhydrite screed, wood, old tiles, chipboard) which require a special treatment.

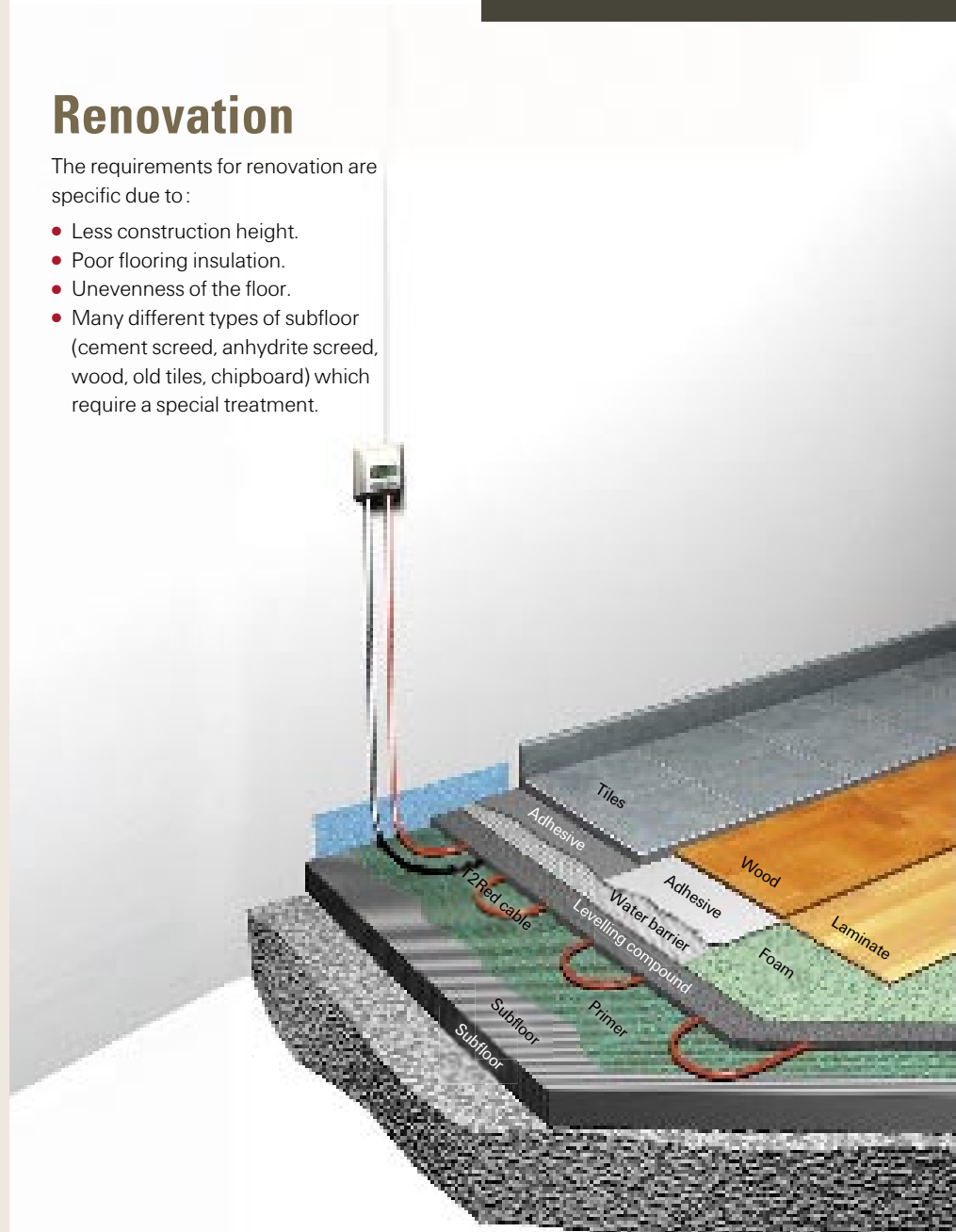

	Floor construction	Approx. output (W/m <sup>2</sup> )	Heating cable length (m/m <sup>2</sup> )	Cable spacing (mm)
Renovation	15 mm cover plus • tiles	100	10	100
		90	8	120
		80	7	140
		70	6	160
		60	5	180
	15 mm cover plus • wood / laminate • plastic covering/ carpet	100	10	100
		80	8	120
		70	7	140
		60	6	160
		50	5	180

## New construction

- Screed thickness 50 mm.
- New construction of floor construction including insulation in respect to the building regulations. Installation of cable will be embedded in a layer of 5 cm screed.

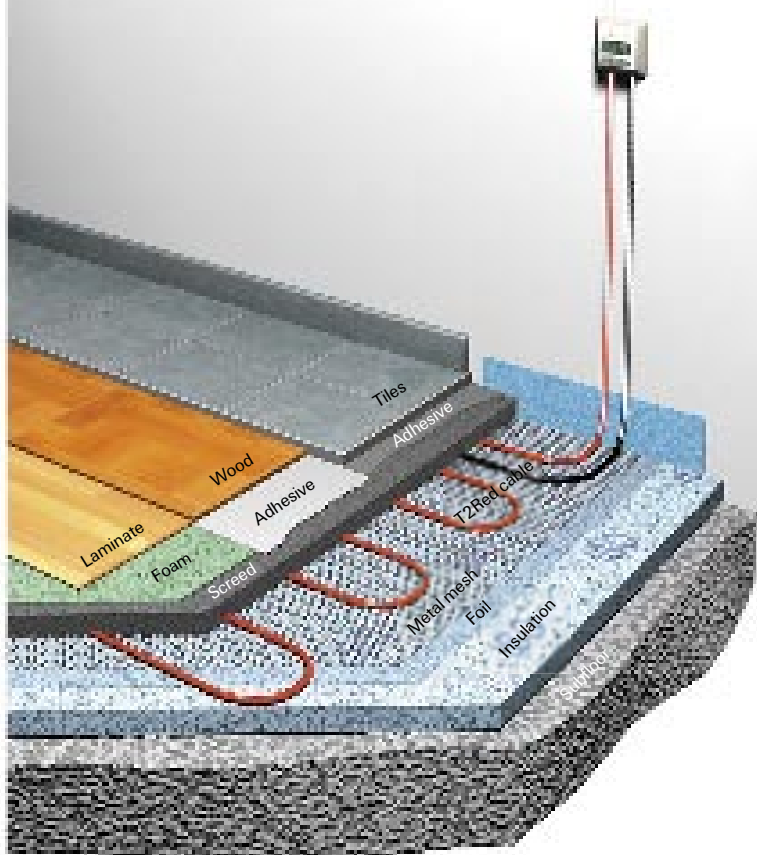

### Which power output do I need?

- 1. New construction – good insulation**  
35 W/m<sup>2</sup> - 60 W/m<sup>2</sup>.
- 2. Renovation – good insulation**  
60 W/m<sup>2</sup> - 100 W/m<sup>2</sup>.
- 3. Insufficient insulation – more output required**  
>100 W/m<sup>2</sup>.

The above values are for comfort underfloor heating. Make a heat-loss calculation if in doubt (insulation, room size, number of windows, ...) or contact us at 0800 969 013.

### Which quantity do I need?

- 1. Select the required power output and required cable length per m<sup>2</sup>**

The table below shows the spacing and required cable length per m<sup>2</sup> and the spacing between the cables. The power output gives approx. 20–25 °C (depending on the subfloor construction).

For higher power output, contact us at 0800 969 013.

- 2. Multiply the cable length m<sup>2</sup> by the total floor surface (m<sup>2</sup>)**

**Example:** Renovation of bathroom (5 m<sup>2</sup>) with tile floor.

1. Select '15 mm cover plus tiles'.
2. Select '80 W/m<sup>2</sup>' → 7 m cable needed /m<sup>2</sup>. Spacing between two cable runs is 140 mm.
3. Required cable length = 7 x 5 = 35 m T2Red heating cable + 2 m for connection in junction box = 37 m.

### Technical data

	Floor construction	Approx. output (W/m <sup>2</sup> )	Heating cable length (m/m <sup>2</sup> )	Cable spacing (mm)
New construction	30–50 mm cover plus • tiles	100	8	120
		90	7	140
		80	6	160
		70	5	180
	30–50 mm cover plus • wood / laminate • plastic covering / carpet	90	8	120
		80	7	140
		70	6	160
		60	5	180

T2Red	
Power output	60 – 100 W/m <sup>2</sup> (5–15 W/m) *
Voltage	AC 230 V
Max. heating cable circuit length	100 m @ 10 A
Min. bending radius	10 mm @ +5 °C
Max. self-generating temperature	45 °C
Max. exposure temperature	65 °C
Max. dimensions (width and height)	6,0 mm x 8,2 mm
Thermostats (see page 26–27)	Raychem TA Raychem TC

\* depending on the cable spacing/floor construction and covering

## How to install in new construction ?

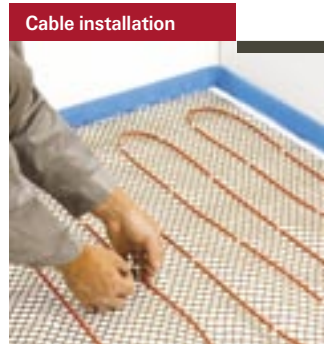

**Cable installation**

Determine the position of the heating zones before starting the installation of the heating cable, in agreement with the planner/architect and screed layer. Attach the cable on a metal mesh (with KBL-10 cable ties) using the desired cable spacing.



**Screed installation**

Carefully apply a screed on top of the cable. Let it cure according to the manufacturers' instructions. Depending on the type of screed this process can start after 7 days (anhydrite screed) or 21 days (cement screed). The first heating up and down procedure of the screed has to be agreed with the supplier and documented.

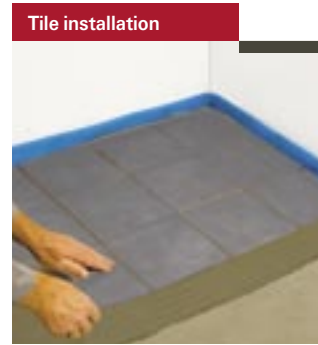

**Tile installation**

Spread the tile adhesive and then lay out and join the tiles. In wet areas, apply a watertight coating before the tile adhesive.

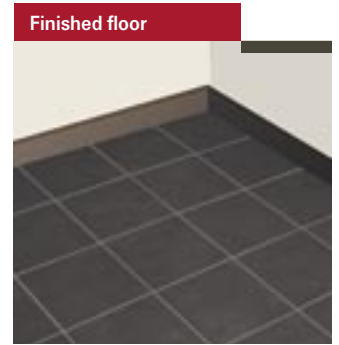

**Finished floor**

Seal between tiles and walls with a silicon sealant. Allow the floor to cure completely before turning the underfloor heating system on.

## How to install in renovation ?

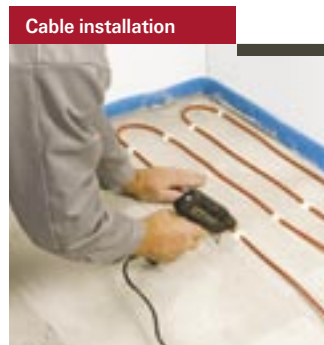

**Cable installation**

Attach the cable (e.g. use glue gun) on the clean floor. Apply a layer of adhesive primer.

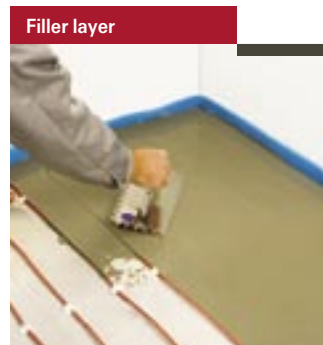

**Filler layer**

Carefully apply an even layer of filler on top of the cable. Let it cure according to the manufacturers' instructions.



**Tile installation**

Place rag cardboard or foam on top of the filler and then lay the wooden or laminated floor according to the instructions of the manufacturer.

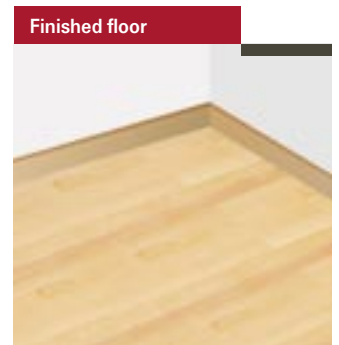

**Finished floor**

Approximately 24 hours later you can enjoy your nice warm floor.

### Attention:

- All electrical work must be performed by an authorised electrician.
- In general it is to be ensured that only floor coverings which are suitable for underfloor heating are used.

### Electrical connection

Max. circuit length	100 m
Cold lead	Not required, direct connection possible in junction box or to thermostat
Electrical protection	10 A circuit breaker (Type C)
Earth leakage current (rcd)	30 mA, 100 ms

Installation of thermostat + sensor (see page 26–27)



**"Zero height" installation.**  
Install T2Red direct in pre-cut grooves.  
Call 0800 969 013.

## What do I need to order?

### 1. T2Red self-regulating cable on spool

Product name	Part number	Description
T2Red	948739-000	T2Red floor heating cable 5-15 W/m 230V



### 2. Components

Product name	Part number	Description
CE-T2Red/ETL	323608-000	T2Red Connection and End Seal Kit

### 3. Thermostats (see page 26–27)

Product name	Part number	Description
Raychem TA	1244-0025 12	Electronic thermostat with LCD display for floor sensing or room sensing applications
Raychem TC	1244-0025 13	Electronic thermostat with timer, illuminated LCD display with floor sensing, room sensing or room sensing with floor sensing limiter



### Pre-terminated T2Red packs

Include:

- Pre-terminated T2Red cable with end seal.
- Thermostat Raychem TA.
- 1 extra front plate.
- 1 sensor cable 2,5 m.
- 1 conduit 2,5 m.
- 1 glue stick.
- 1 installation manual.
- 1 commissioning report.



Product name	Length (m)	Part number	Description
T2Red pack -16M	16 m	389736-000	T2Red-pack 16 m incl. Thermostat and spare termination kit
T2Red pack -23M	23 m	658414-000	T2Red-pack 23 m incl. Thermostat and spare termination kit
T2Red pack -30M	30 m	016962-000	T2Red-pack 30 m incl. Thermostat and spare termination kit
T2Red pack -37M	37 m	066424-000	T2Red-pack 37 m incl. Thermostat and spare termination kit
T2Red pack -44M	44 m	416966-000	T2Red-pack 44 m incl. Thermostat and spare termination kit
T2Red pack -58M	58 m	531288-000	T2Red-pack 58 m incl. Thermostat and spare termination kit
T2Red pack -72M	72 m	318684-000	T2Red-pack 72 m incl. Thermostat and spare termination kit
T2Red pack -86M	86 m	275876-000	T2Red-pack 86 m incl. Thermostat and spare termination kit
T2Red pack -100M	100 m	036848-000	T2Red-pack 100 m incl. Thermostat and spare termination kit

### Accessories

Product name	Part number	Description
CE-T2Red/ETL	323608-000	T2Red Connection and End Seal Kit
S-T2Red	397408-000	T2Red Splice Kit
T2Red starter-pack 300 m	821116-000	Complete starter pack: 300 m heating cable, 5 thermostats, 10 connection and end seal kit-kits, trolley
T2Red trolley	701370-000	T2Red trolley
T2Red hot glue sticks	503052-000	70 pcs in 1 box
KBL-10	102823-000	Cable ties

# T2Red with T2Reflecta : The energy-efficient system

## 2 T2Red with T2Reflecta

### System components

- T2Red self-regulating heating cable.
- T2Reflecta plate:
  - With installation grooves.
  - With insulation + integrated aluminum heat distribution layer.
- End plates.



### Applications

Living rooms, kitchens, bathrooms, dining room, children's room, conservatories:

- **Top floor:** Tiles, parquet, natural stone, laminate, carpet\*.
- **Subfloor:** Cement screed; anhydrite screed, wooden floor, gypsum board, timber floor board, asphalt screed.

\*must be suitable for underfloor heating (maximum resistance to heat transfer 0,15 W/m<sup>2</sup>K)

### The energy-efficient system

- 20% extra energy saving through integrated insulation.
- Even and adaptive heat distribution in floor.
- Flexible interior design. Thanks to the self-regulating effect, there is no risk for overheating under carpets, furniture, etc.
- Automatic self-regulating output depending on environment (more output in cold zones, less output in warm zones).
- No measurable electro-magnetic fields.
- Long life and maintenance free.

### Advantages

#### Uniform temperature levels across the room.

Thermo graphic

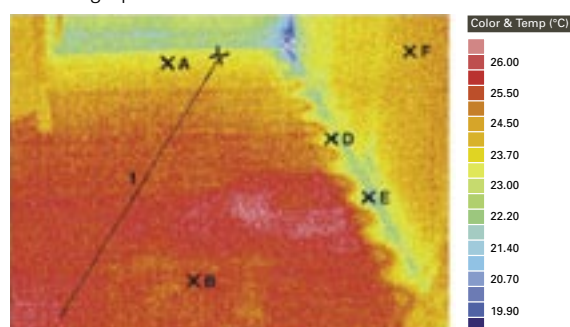

The aluminum layer of the plate guarantees a uniform heat distribution across the room.

Profile: 1

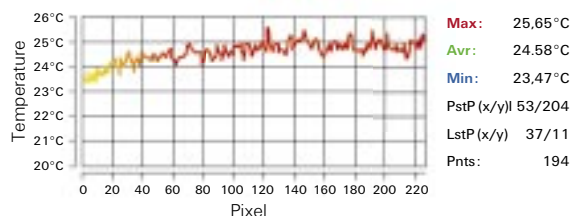

Small temperature differences across the room

#### Extremely fast heat up

Heat transportation in stationary air, after 1 hour operation.

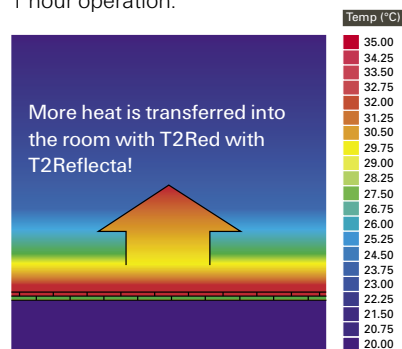

T2Red with T2Reflecta - 100 W/m<sup>2</sup> under tiles (after 1 hour operation).

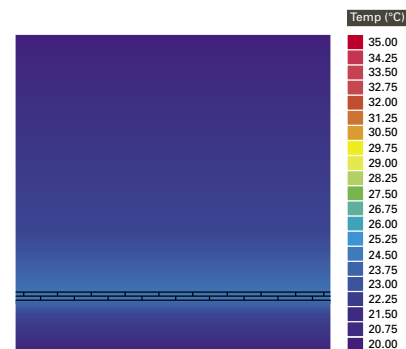

Heating cable in filler - 100 W/m<sup>2</sup> under tiles (after 1 hour operation).

#### Reduced heat-loss

Heat where it matters: under the top floor.

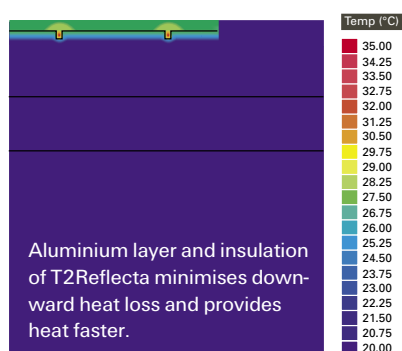

T2Red with T2Reflecta on concrete.

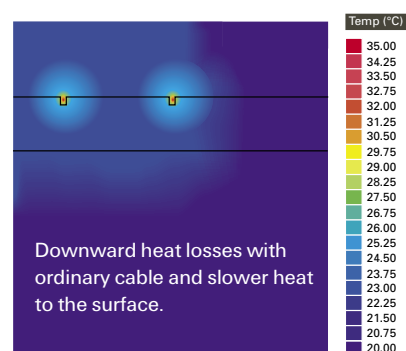

Heating cable in filler on concrete subfloor.

## Which power output do I need?

**1. New construction – good insulation**  
35 W/m<sup>2</sup> - 60 W/m<sup>2</sup>.

**2. Renovation – good insulation**  
60 W/m<sup>2</sup> - 100 W/m<sup>2</sup>.

**3. Insufficient insulation – more output required**  
>100 W/m<sup>2</sup>.

The above values are for comfort underfloor heating. Make a heat-loss calculation if in doubt (insulation, room size, number of windows, ...) or contact us at 0800 969 013.

Top floor type	Approx. output (W/m <sup>2</sup> )	Heating cable length (m/m <sup>2</sup> )	Cable spacing (mm)
Tile flooring	45	3,3	300
	70	5	200
	100	10	100
Wood/Laminate/ Plastic floor covering/carpet	35	3,3	300
	50	5	200
	70	10	100

## Technical data

T2Reflecta plate	
Materials	Alu (0,5 mm thickness/ & EPS (12,5 mm)
Plate dimensions	720 mm x 400 mm x 13 mm
End plate dimensions	100 mm x 400 mm x 12,5 (no alu)
Fire classification	DIN 4 102-B1
U-value	2,33 W/m <sup>2</sup> K
Thermal conductivity	0,033 W (mK)
Thermal expansion coefficient	2,4 x 10 <sup>5</sup> 1/K
Long term pressure capability	140 kPa (14000 kg/m <sup>2</sup> )

Technical data of the T2Red cable see page 9.



## Which quantity do I need?

**1. Select the required power output and required T2Red cable length per m<sup>2</sup>**

The table below shows the required spacing and cable length per m<sup>2</sup> and the spacing between the cables. The power output gives approx. 20–25 °C.

**2. Determine the required number of T2Reflecta insulated plates**

One T2Reflecta insulated plate package covers 3,04 m<sup>2</sup>.

It consists of 10 T2Reflecta plates (720 x 400 mm) and six end plates (100 x 400 mm).

**Example:** Entrance hall of 5 m<sup>2</sup> with wooden floor:

**1.** Select '70 W/m<sup>2</sup>' power output → 10 m T2Red cable per m<sup>2</sup>.

Spacing between two cable runs is 100 mm.

**2.** Number of T2Reflecta insulated plates = 5 ÷ 3,04 = 1,6 → 2 packs.

## How to install laminate or wood on T2Red with T2Reflecta ?

- T2Reflecta can be installed as a floating system, which saves days or weeks of curing time.
- No filler needed.
- The wooden floor can be laid directly on the T2Reflecta plates.



The floating system is the fastest installation possible: no curing time.

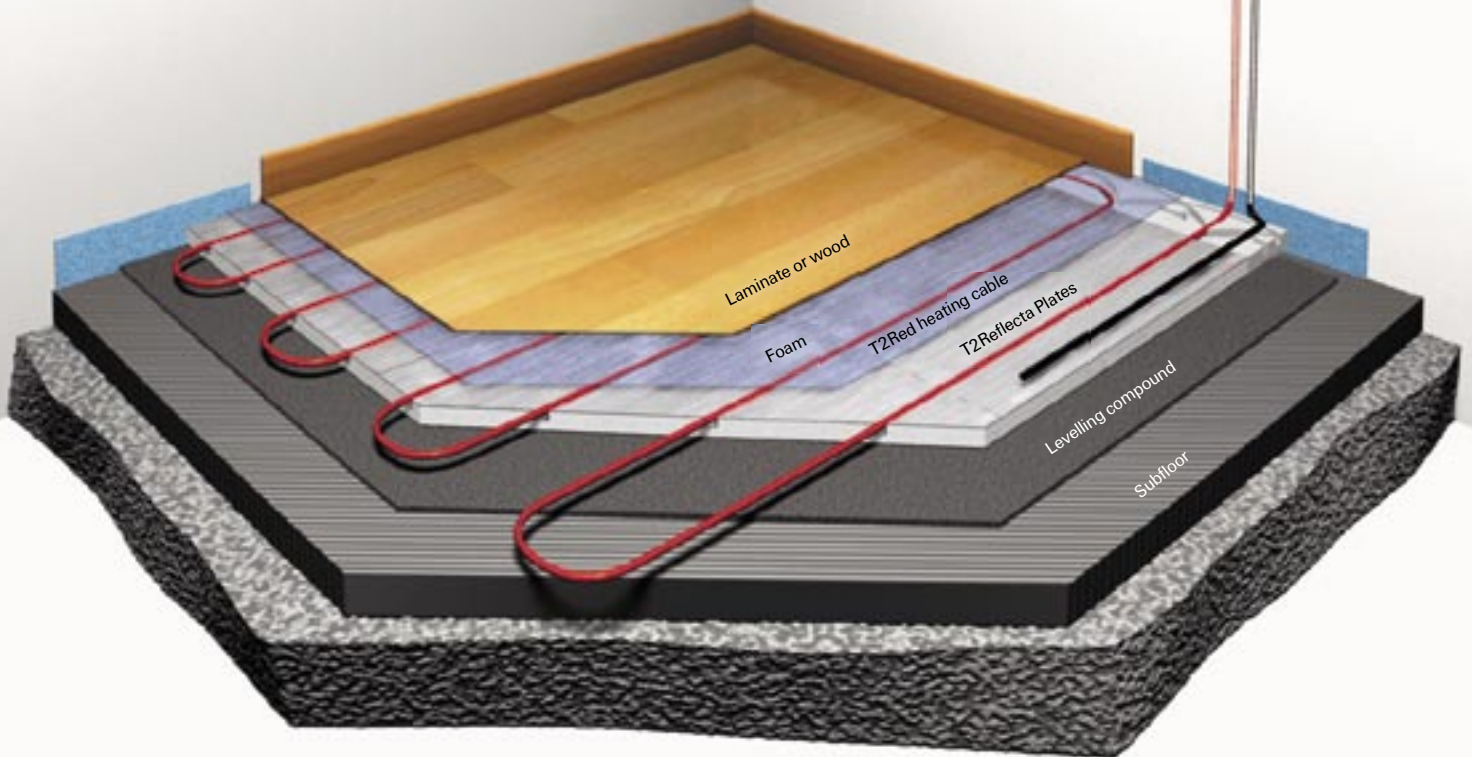

## Floating system

Installation of plates



Lay out the T2Reflecta plates (no need to screw or glue them) on the subfloor.

Install heating cable



Place the T2Red heating cable into the grooves. The desired heat output is determined by the spacing of the cable.

Installation of the wooden floor



Place wood floor underlay on top of the T2Reflecta plates and then lay the new wooden or laminate floor according to the instructions of the manufacturer.

Finished floor

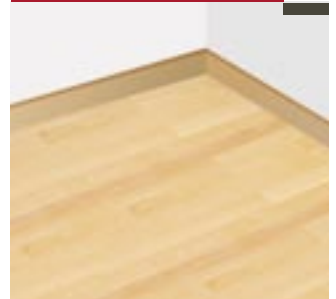

Straight away your customers can enjoy your nice warm floor.

### Attention:

- All electrical work must be performed by an authorised electrician.
- Make sure to use a floor covering that is suitable for underfloor heating.



## How to install tiles or natural stone on T2Red with T2Reflecta ?



Raychem systems are certified with building materials from leading brands. More on p. 29 [www.raychemfloorheating.com](http://www.raychemfloorheating.com)



Use 15 screws per plate for wooden subfloors

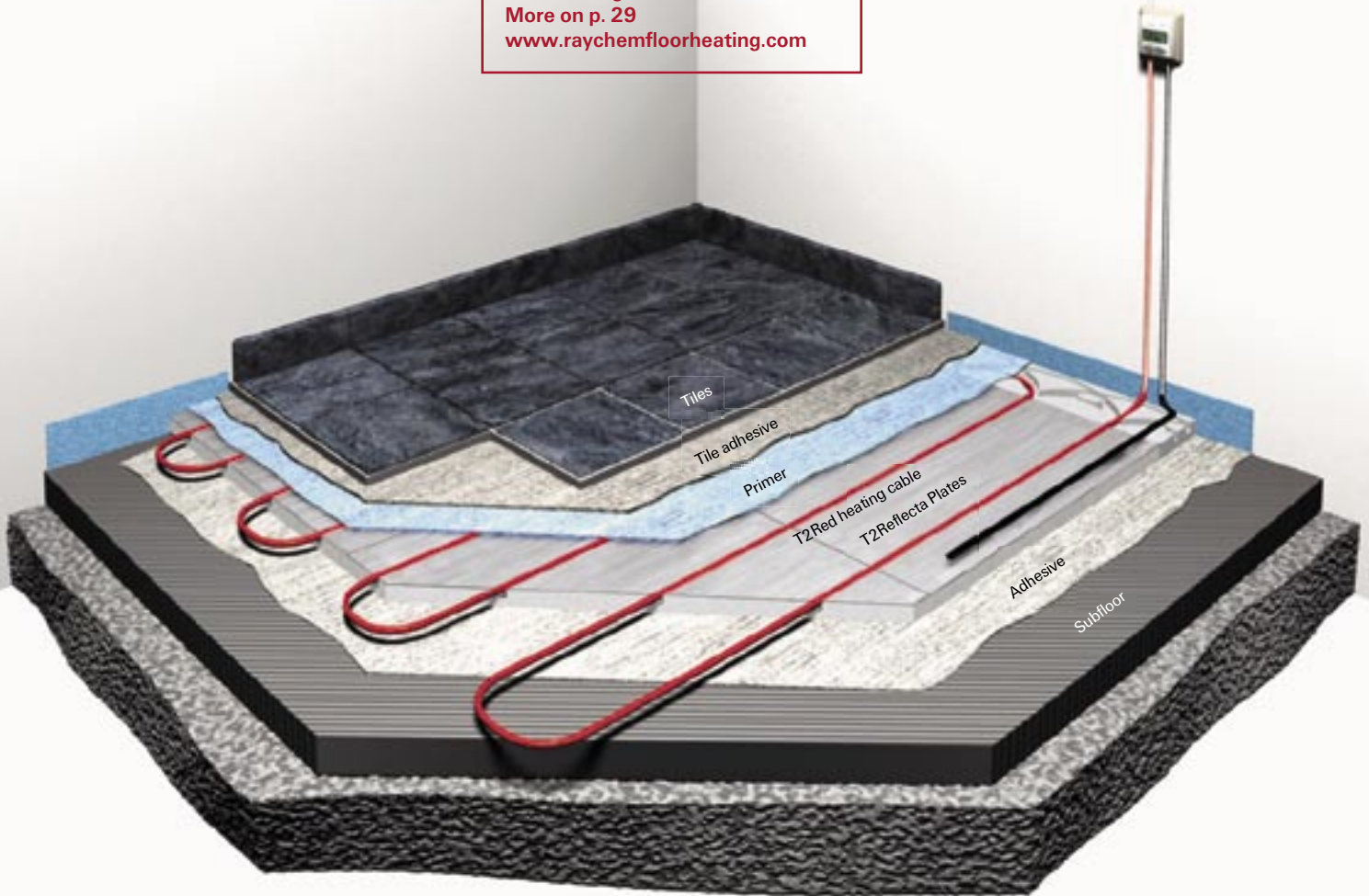

Apply T2Reflecta Adhesive A-FIX onto the subfloor (or use 15 screws per plate for wooden subfloors). Place the T2Reflecta plates on top of the glue.



Place the T2Red heating cable in the grooves. The desired heat output is determined by how closely you space the cable (100, 200 or 300 mm).

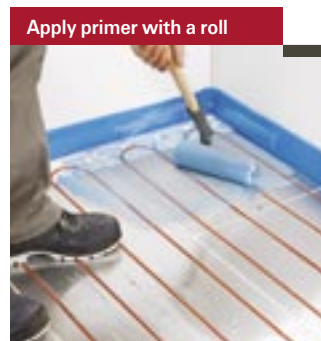

Apply the Primer P-Fix on the aluminum layer.



Tiles are placed directly on top of the T2Reflecta plates with tile adhesive, according to the instructions. Approximately 24 hours after joining the tiles, you can enjoy your nice warm floor.

### Attention:

- All electrical work must be performed by an authorised electrician.
- Make sure to use a floor covering that is suitable for underfloor heating.

## Choose your preferred fixing system for T2Reflecta plates

Working steps	T2Reflecta Fix-System for standard installation	T2Reflecta S-System for a very fast installation*
Fix the plates on the subfloor	T2Reflecta A-Fix Cement-based adhesive Walk on 24 hours 	T2Reflecta Adhesive S Special dispersion adhesive Walk on 4 hours 
Apply primer on the T2Reflecta Plates	T2Reflecta P-Fix Special primer 	Not necessary The tiles can be directly fixed on the T2Reflecta plates
Install the tiles	Any flexible tile adhesive or natural stone adhesive	T2Reflecta Adhesive S Walk on 4 hours
Total curing time	24 hours	8 hours

\*not suitable for natural stones

## What do I need to order?

### 1. T2Reflecta insulated plates

Product name	Part number	Description
T2Reflecta-pack 3,0 m <sup>2</sup>	450052-000	10 pcs of T2Reflecta-plates (720 mm x 400 mm) and 6 pcs of end plates (100 mm x 400 mm) for 3,12 m <sup>2</sup>
T2Reflecta-pack 1,0 m <sup>2</sup>	6012-8946251	3 pcs of T2Reflecta-plates (720 mm x 400 mm) and 2 pcs of end plates (100 mm x 400 mm) for 0,944 m <sup>2</sup>
T2Reflecta-end plates-pack	241662-000	6 pcs of extra end plates (100 mm x 400 mm)



### 2. T2Red self-regulating cable on spool

Product name	Part number	Description
T2Red on spool	948739-000	T2Red floor heating cable 5-15 W/m 230V

Components	Part number	Description
CE-T2Red/ETL	323608-000	T2Red connection and End seal-kit



### 3. Accessories

Fixing materials for Tiles and Natural stone tiles		
Product name	Part number	Description
T2Reflecta A-Fix	1244-001372	Adhesive for gluing T2Reflecta plates on the subfloor, 15 kg paper bag for 6 m <sup>2</sup> . Consumption: 2.2 kg/cm <sup>2</sup>
T2Reflecta P-Fix	1244-001371 1244-003528	Primer for the aluminium layer of the T2Reflecta plates to apply standard natural stone or tile adhesive: <ul style="list-style-type: none"> <li>• 5 kg bucket for 33 m<sup>2</sup>. Consumption: 150 g/m<sup>2</sup>.</li> <li>• 1 kg bucket for 6 m<sup>2</sup>. Consumption: 150 g/m<sup>2</sup>.</li> </ul>



Fixing materials for tiles – quick solution		
Product name	Part number	Description
T2Reflecta adhesive S	892124-000	1 bucket for fixing approx. 6-9 m <sup>2</sup> of T2Reflecta plates or 3 m <sup>2</sup> for fixing of both T2Reflecta plates and tiles



### 4. T2Reflecta packs

Product name	Part number	Description
T2Reflecta-Laminate-10Plus	1244-002561	Complete pack for 10 m <sup>2</sup> . (T2Red 100 m heating cable, 1 CE-Kit, 4 T2Reflecta packs = 33 T2Reflecta plates and 20 end plates)
T2Reflecta-Tiles-10Plus	1244-002564	Complete pack for 10 m <sup>2</sup> . (T2Red 100 m heating cable, 1 CE-Kit, 4 T2Reflecta packs = 33 T2Reflecta plates and 20 end plates; 2 Adhesive A-FIX, 1 Primer P-FIX)
T2Reflecta-Tiles-10Plus-S	1244-003227	Complete pack for 10 m <sup>2</sup> . (T2Red 100 m heating cable, 1 CE-Kit, 4 T2Reflecta packs = 33 T2Reflecta plates and 20 end plates; 4 T2Reflecta Adhesive-S)



### 5. Thermostats (see page 26–27)

Product name	Part number	Description
Raychem TA	1244-002512	Electronic thermostat with LCD display for floor sensing or room sensing applications
Raychem TC	1244-002513	Electronic thermostat with timer, illuminated LCD display with floor sensing, room sensing or room sensing with floor sensing limiter



# T2QuickNet: The thin, self-adhesive heating mat

## 3 T2QuickNet

Self-adhesive, 3 mm thick underfloor heating mat for direct installation under ceramic tiles or natural stone.

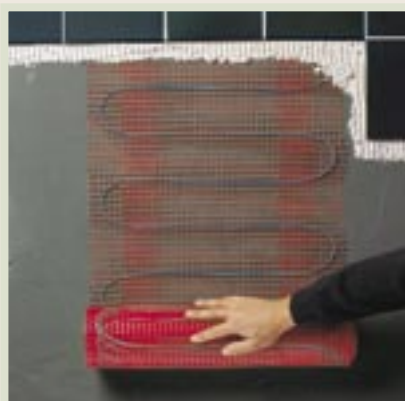

- Only 3 mm thick!
- **One** cold lead (dual wire system).
- Ideal as direct underfloor heating for embedding in tile adhesive or filler underneath the top floor.
- Maximum construction height including tiles is 15 mm.

### Applications

Living rooms, kitchens, bathrooms, dining rooms, children's rooms, conservatories:

- **Top floor:** Tiles, natural stone (max. 30 mm thick).
- **Subfloor:** Cement screed, anhydrite screed, wooden floor\*, Gypsum board, timber floor board.

\* T2QuickNet-160 is not suitable for direct installation on wooden subfloors.

### Which T2QuickNet mat do I need?

#### T2QuickNet-90

- For well insulated floors.
- For complementary heating.

#### T2QuickNet-160

- For fast heat up.
- For poor insulated subfloors.



Area (m <sup>2</sup> )	Output T2QuickNet-90 (W)	Output T2QuickNet-160 (W)	Dimensions (W x L)
1	90	160	0,5 x 2,0
1,5	135	240	0,5 x 3,0
2	180	320	0,5 x 4,0
2,5	225	400	0,5 x 5,0
3	275	480	0,5 x 6,0
3,5	315	560	0,5 x 7,0
4	360	640	0,5 x 8,0
4,5	405	720	0,5 x 9,0
5	455	800	0,5 x 10,0
6	545	960	0,5 x 12,0
7	630	1120	0,5 x 14,0
8	725	1280	0,5 x 16,0
9	800	1440	0,5 x 18,0
10	915	1600	0,5 x 20,0
12	1100	–	0,5 x 24,0
For a surface bigger than 12 m <sup>2</sup> ; a pack of 10 m <sup>2</sup> <b>without thermostat</b> is available			
10	915	1600	0,5 x 20,0

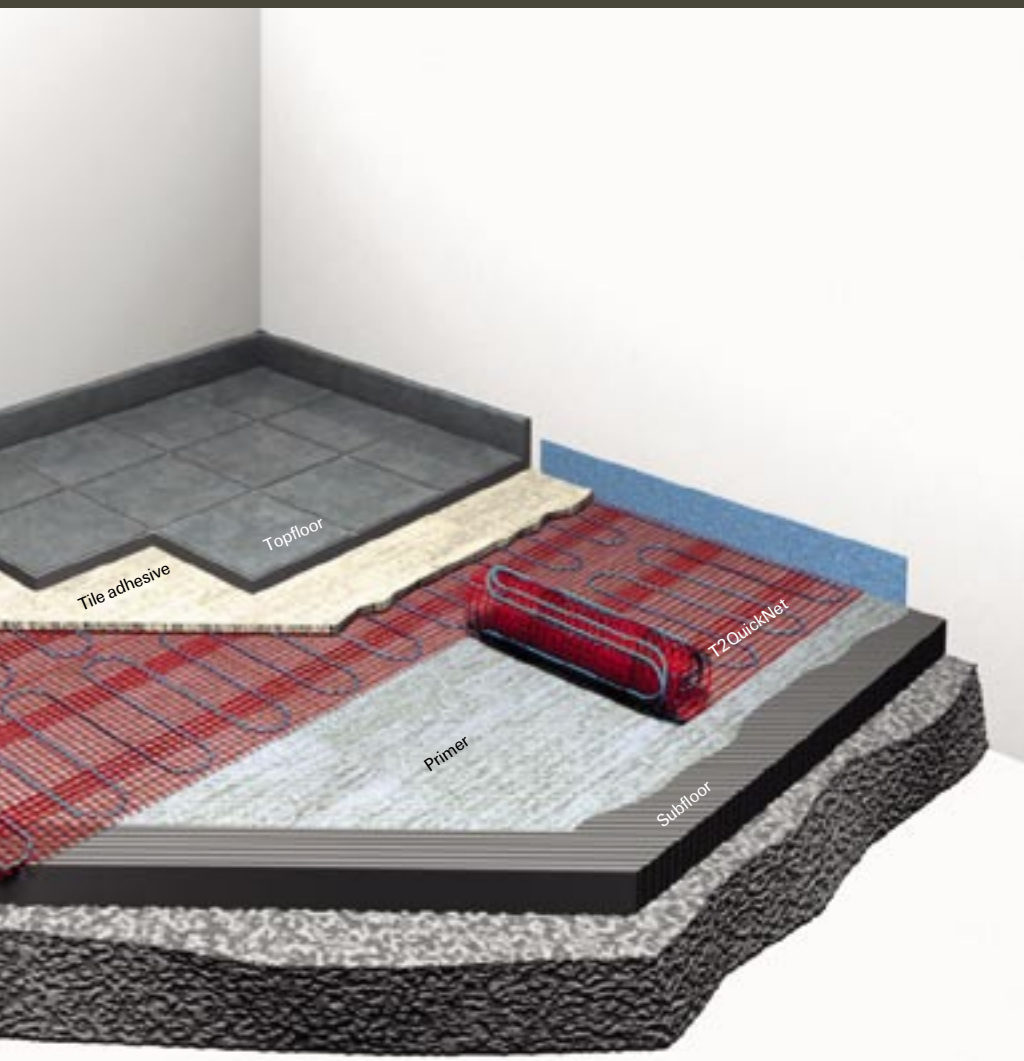

### Which quantity do I need?

T2QuickNet is available in ready-made kits. All T2QuickNet kits include heating mat with pre-attached cold lead cable, thermostat with sensor (+installation conduit) and complete installation instructions.





Calculate the total surface (m<sup>2</sup>) to be heated and select the T2QuickNet mat with a smaller surface area closest in size.

**Example:** Renovation of bathroom (9,4 m<sup>2</sup>) with tile floor. Select T2QuickNet pack for 9 m<sup>2</sup>.

### Technical data

T2QuickNet -heating mat composition		
	T2QuickNet-90	T2QuickNet-160
Heating cable	Constant wattage cable 11 W/m	
Power output	Max. 90 W/m <sup>2</sup>	160 W/m <sup>2</sup>
Voltage	AC 230 V	AC 230 V
Cable spacing	90 mm	70 mm
Insulation outer jacket	LSOH Polyolefin	LSOH Polyolefin
Cold lead length	2,5 m	5 m
Heating cable diameter	3,4 mm	3,4 mm
Min. bending radius	30 mm	30 mm
Mat material	Fiber glas; self adhesive	Fiber glas; self-adhesive
Net width	50 cm	50 cm
Thermostats (see page 26–27)	Raychem TA	Raychem TC

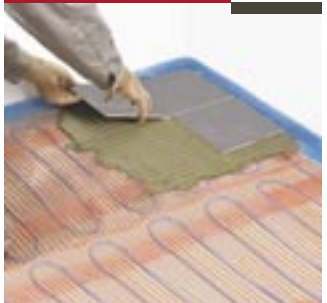
## How to install T2QuickNet?

 <p><b>Cable installation</b></p>	 <p><b>Apply tile adhesive</b></p>	 <p><b>Tile installation</b></p>	 <p><b>Finished floor</b></p>
<p>Roll out the heating mat on the clean floor. Apply a layer of adhesive primer.</p>	<p>Apply the tile adhesive directly on the T2QuickNet mat. In wet areas, apply a filler and watertight coating before the tile adhesive.</p>	<p>Spread the tile adhesive and let it cure according to instructions. Then install the tiles.</p>	<p>Sealed tiles with silicon. Allow the floor to cure completely before turning the underfloor heating system on.</p>

### Attention:

- All electrical work must be performed by an authorised electrician.
- Make sure to use a floor covering that is suitable for underfloor heating.



To repair a broken cable use the T2QuickNet repair kit. See accessories page 24.

## Installation information

The installation of the T2QuickNet mat is fast, safe and smart:

- The T2QuickNet mat -with pre-mounted heating cable is available in ready-made lengths.
- Only 3 mm thick; no need to raise floor levels.
- Self-adhesive backing; no need for glue or staples.
- Is laid directly in the filler or the adhesive.
- Needs only one cold lead.
- For rooms with a complicated shape the cable can be easily loosened from the net to cover all heating areas.
- The cable may not be spliced, shortened, extended, or crossed.

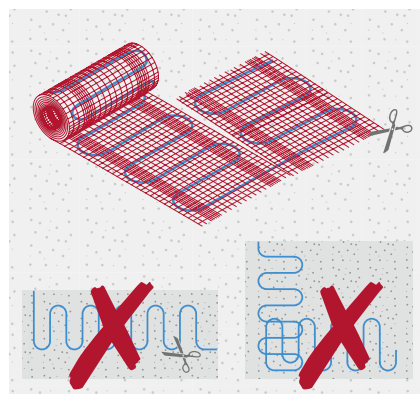

To make a turn, cut the mat (avoid damaging the cable) and turn.

## Electrical connection T2QuickNet

Installation of the heating cable Thermostat + sensor		
Max. load without contactor to thermostat	3000 W	
Thermostat	Raychem TA / Raychem TC (see page 26–27)	
Electrical connection T2QuickNet		
	T2QuickNet 90	T2QuickNet 160
Heating cable circuit length	33 m <sup>2</sup>	18 m <sup>2</sup>
Cold lead	2,5 m	5 m
Electrical protection circuit breaker	13 A max.	
FI earth leakage current (rcd)	30 mA, 100 ms	



T2Quicknet-90 can be installed on a wooden subfloor under tiles. Call 0800 969 013 to find out more about the ideal installation method.



T2QuickNet heating mats can be installed direct underneath the tile top floor close to bath tubs and showers and in walk-in showers.



Raychem systems are certified with building materials from leading brands. More on p. 29 [www.raychemfloorheating.com](http://www.raychemfloorheating.com)

## What do I need to order?

### Heating mat pack

#### T2QuickNet-Plus-160 kit (with TC thermostat)

##### Pack contents:

- 1 self adhesive T2QuickNet mat 160 W/m<sup>2</sup>, 1 cold lead 5 m.
- 1 thermostat Raychem TC polarwhite.
- 1 extra front plate
- 1 sensor end plug.
- 1 sensor installation conduit.
- 1 installation manual.
- 1 commissioning report.



Product name	Part number	Area (m <sup>2</sup> )	Output (W)	Dimensions (W x L in m)
T2QuickNet-P-160-1,0/Therm	424320-000	1	160	0,5 x 2,0
T2QuickNet-P160-1,5/Therm	1244-001827	1,5	240	0,5 x 3,0
T2QuickNet-P-160-2,0/Therm	806564-000	2	320	0,5 x 4,0
T2QuickNet-P160-2,5 /Therm	1244-001828	2,5	400	0,5 x 5,0
T2QuickNet-P-160-3,0/Therm	802530-000	3	480	0,5 x 6,0
T2QuickNet-P160-3,5/Therm	1244-001829	3,5	560	0,5 x 7,0
T2QuickNet-P-160-4,0/Therm	404112-000	4	640	0,5 x 8,0
T2QuickNet-P160-4,5/Therm	1244-001830	4,5	720	0,5 x 9,0
T2QuickNet-P-160-5,0/Therm	055938-000	5	800	0,5 x 10,0
T2QuickNet-P-160-6,0/Therm	825740-000	6	960	0,5 x 12,0
T2QuickNet-P-160-7,0/Therm	440084-000	7	1120	0,5 x 14,0
T2QuickNet-P-160-8,0/Therm	782896-000	8	1280	0,5 x 16,0
T2QuickNet-P-160-9,0/Therm	857168-000	9	1440	0,5 x 18,0
T2QuickNet-P-160-10,0/Therm	128170-000	10	1600	0,5 x 20,0

### Extension kits

#### T2QuickNet 160 ( without thermostat)

##### Pack contents:

- 1 self-adhesive T2QuickNet mat 160 W/m<sup>2</sup>, 1 cold lead 5 m.
  - 1 installation manual.
  - 1 commissioning report.
- Select the right thermostat on page 26–27.



Product name	Part number	Area (m <sup>2</sup> )	Output (W)	Dimensions (W x L in m)
T2QuickNet-P-160-1,0	986618-000	1	160	0,5 x 2,0
T2QuickNet-P-160-1,5	1244-001831	1,5	240	0,5 x 3,0
T2QuickNet-P-160-2,0	060364-000	2	320	0,5 x 4,0
T2QuickNet-P-160-2,5	1244-001832	2,5	400	0,5 x 5,0
T2QuickNet-P-160-3,0	168506-000	3	480	0,5 x 6,0
T2QuickNet-P-160-3,5	1244-001833	3,5	560	0,5 x 7,0
T2QuickNet-P-160-4,0	036330-000	4	640	0,5 x 8,0
T2QuickNet-P-160-4,5	1244-001834	4,5	720	0,5 x 9,0
T2QuickNet-P-160-5,0	441162-000	5	800	0,5 x 10,0
T2QuickNet-P-160-6,0	349790-000	6	960	0,5 x 12,0
T2QuickNet-P-160-7,0	712522-000	7	1120	0,5 x 14,0
T2QuickNet-P-160-8,0	605750-000	8	1280	0,5 x 16,0
T2QuickNet-P-160-9,0	723132-000	9	1440	0,5 x 18,0
T2QuickNet-P-160-10,0	728236-000	10	1600	0,5 x 20,0

## Heating mat pack

### T2QuickNet 90 (with TA thermostat)



#### Pack contents:

- 1 self-adhesive T2QuickNet 90 W/m<sup>2</sup> mat, 1 cold lead 2,5 mm.
- 1 thermostat Raychem TA polar white.
- 1 extra front plate.
- 1 sensor end plug.
- 1 sensor installation conduit.
- 1 installation manual.
- 1 commissioning report.



Product name	Part number	Area (m <sup>2</sup> )	Output (W)	Dimensions (W x L in m)
T2QuickNet-1,0	6012-8948401	1	90	0,5 x 2,0
T2QuickNet-1,5	6012-8948415	1,5	135	0,5 x 3,0
T2QuickNet-2,0	002974-000	2	180	0,5 x 4,0
T2QuickNet-2,5	6012-8948416	2,5	225	0,5 x 5,0
T2QuickNet-3,0	130640-000	3	275	0,5 x 6,0
T2QuickNet-3,5	6012-8948417	3,5	320	0,5 x 7,0
T2QuickNet-4,0	114372-000	4	360	0,5 x 8,0
T2QuickNet-4,5	6012-8948418	4,5	405	0,5 x 9,0
T2QuickNet-5,0	332398-000	5	450	0,5 x 10,0
T2QuickNet-6,0	606482-000	6	545	0,5 x 12,0
T2QuickNet-7,0	017708-000	7	630	0,5 x 14,0
T2QuickNet-8,0	043254-000	8	725	0,5 x 16,0
T2QuickNet-9,0	171520-000	9	800	0,5 x 18,0
T2QuickNet-10,0	742077-000	10	915	0,5 x 20,0
T2QuickNet-12,0	441639-000	12	1100	0,5 x 24,0
<b>Extension pack for surfaces above 12 m<sup>2</sup>. Without thermostat.</b>				
T2QuickNet-10,0/No Therm	034118-000	10	915	0,5 x 20,0

### 3. Thermostats (see page 26–27)

Product name	Part number	Description
Raychem TA	1244-002512	Electronic thermostat with LCD display for floor sensing or room sensing applications 
Raychem TC	1244-002513	Electronic thermostat with timer, illuminated LCD display with floor sensing, room sensing or room sensing with floor sensing limiter 

## Accessories

Product name	Part number	Description
T2QuickNet Repair kit	927536-000	Repair and Extension kit for T2QuickNet





# Thermostats

No one likes to spend a fortune on electricity. That's why our Raychem underfloor heating systems are designed to minimise electricity costs. Raychem digital thermostats combine unique features with a big LCD display and easy operation.

## Smart features for an easier operation

### User friendly

- Large Star-LCD-display.
- Heat-Booster function for fast heat up (+5 °C for max. 2 hours).
- Read out of the actual floor sensor temperature.
- Calibration can be adjusted to other measuring devices in the room.

### Design for long lasting safety

- Safe disconnection due to 2-pole on/off switch.
- Protection class IP 21.
- Fail - safe operation.

### Easy to install

- Big terminals + earth terminal for an easy and fast connection.
- Automatic detection of the sensor mode where appropriate (floor / room / room with limiter).

### Flexible in design

- Compatible with most switch gear (extra square front in the box).
- Silver colour version available.

Our thermostats are compatible with Switch gear of the leading brands

**Busch-Jaeger · Merten · Eljo · Ensto · Gira · Jung · Elko.**

## Raychem TA Comfort Thermostat

Saves energy by the temperature set-back function directly (-3,5 °C) or via remote timer.



## Technical data Raychem TA

Temperature range floor sensing	5–35°C
Temperature range room sensing	5–40°C
Voltage	230 V AC
Protection class	IP 21
Sensor type	NTC, 10kΩ/25°C
Sensor cable length	3 m
Dimensions	H 82 x W 82 x D 54 mm

## Ordering information

Product name	Colour	Part number	Description
Raychem TA	polarwhite	1244-002512	Thermostat with floor and ambient sensor
Silver-R-TA	silver	1244-003493	Silver colored front plate for TA thermostat
Sensor-N10kΩ	–	1244-002952	Spare sensor
Adapter-UK-wall box	–	1244-003527	Adaptor frame for UK wall boxes

# Performance controls for increased efficiency

## Raychem TC Timer Thermostat

- Large blue illuminated display.
- Timer function, programmable each day per week in 30 minutes blocks.
- 4 selectable pre-programmes.
- 1 user specific programme.
- Increased comfort due to the intelligent **adaptive function**: calculates when the

heating is to be switched on to make sure that the comfort temperature is reached when required.

- Floor sensing; room sensing or room sensing including floor temperature limiter for temperature-sensitive top floors (e.g. wood).



### Technical data Raychem TC

Temperature range floor sensing	5–35°C
Temperature range room sensing	5–40°C
Temperature range floor limiter	low 5°C/ high 35°C
Switch capacity/Voltage	13 A/230 V AC
Protection class	IP 21
Sensor type	NTC, 10kΩ/25°C
Sensor cable length	3 m
Dimensions	H 82 x W 82 x D 54 mm

### Ordering information

Product name	Colour	Part number	Description
Raychem TC	polarwhite	1244-002513	Timer thermostat with floor and ambient sensor
Silver-R-TC	silver	1244-003494	Silver colored front plate for TC thermostat
Sensor-N10kΩ	–	1244-002952	Spare sensor
Adapter-UK-wall box	–	1244-003527	Adaptor frame for UK wall boxes

## Wiring diagrams

### Direct, connection – one heating cable

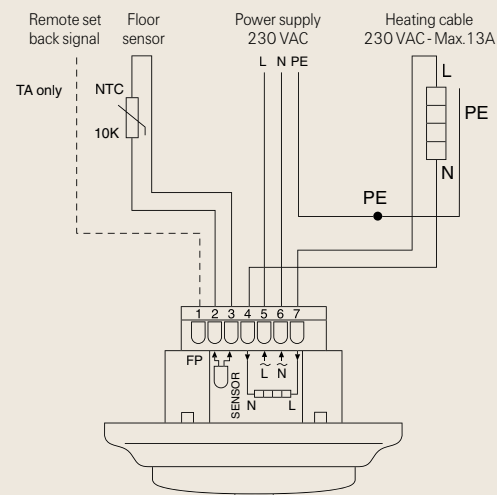

### Connection via contactor e.g. 3 heating cables

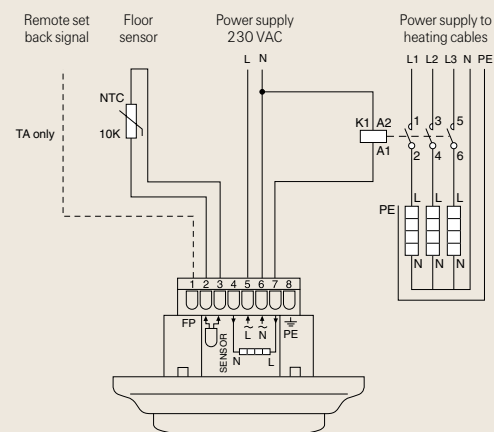

# Raychem Smart Services

Raychem offers a set of tools and services that aims to simplify the professional installers' life. Not only do we offer the best quality products; we also back them up with unrivalled services.

## Free design service

Save time on preparing your next project and ask for our free design service. With a simple request, our engineers will provide a detailed offer, using our unique software.

### What will you get ?

- Project list with all relevant project data.
- Detailed bill of materials.
- Installation plan with circuit lengths and technical details of the recommended heating system in 2- or 3-D.
- Recommendation sheet for the building materials.

### How can you get it ?

Contact your local supplier or just send a sketch or drawing of your room(s) to us by :

- Fax 0800 96 86 24.
- E-mail : [salesUK@tycothermal.com](mailto:salesUK@tycothermal.com).
- Use the Faxform for Free design service at the last page of this brochure.



## Installation plan

Installation plan with circuit lengths and technical details of the recommended heating system in 2- or 3-D.

The installation plan makes your life easier too. It details the start and end of each circuit and the position of the thermostats.



T2Red installation plan



T2Reflecta with T2Red installation plan



T2QuickNet installation plan



Our website helps you discover, sell and answers questions :  
[www.raychemfloorheating.com](http://www.raychemfloorheating.com)

### Power Consumption Calculator



Commercial and technical arguments to convince your customer of the advantages of Underfloor Heating. For instance a power consumption calculator demonstrating the low operation costs of the system.

### Design wizard



A step-by step guide that will help you select the right product for your application. It will also calculate the quantities you will need to complete your project. You will be taken through different steps that will produce a bill of materials, that you could then submit to us for quotation.

### Compatible building material recommendations

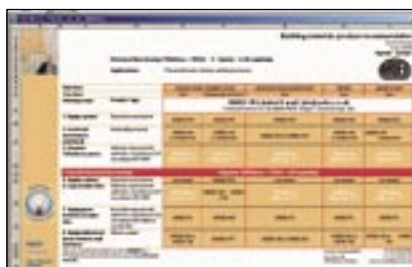

Compatible building material selection : Raychem systems have been tested and approved to building materials from the leading brands in Europe. Our website tells you which products of your regular brands are compatible with underfloor heating.

[www.tycothermal.com/floorheating/BM](http://www.tycothermal.com/floorheating/BM)



To learn more about these smart services, call our free number : 0800 969 013

## Request form for free Design Service for **Raychem** Underfloor Heating Projects

Please send it to your Tyco Thermal Controls representative or fax to 0800 96 86 24

### Your address:

Name: .....

Street: .....

Zip Code: .....

City: .....

Country: .....

E-mail: .....

Phone: .....

Fax: .....

### Your project data:

Project name: .....

Customers name: .....

Street: .....

Zip Code: .....

City: .....

Country: .....

### Constuction type:

Single family house     Apartment     Hotel

Commercial building     Retirement home

other: .....

### Heating purpose:

Comfort heating

Room heating ..... W/m<sup>2</sup> required output

### Floor covering:

Subfloor: .....

### Topfloor:

Tiles/natural stone

Wood/laminate

### Thermostat:

TA Thermostat

TC Thermostat

Please send me following information by (dd/mm/yy): .....

**Quote**  
(incl. material list, project list, installation plan 3D)

**Technical Data sheet**

Comments: .....

.....

**Building materials recommendation**  
(adhesive, leveling compound, grout filler etc.) for the installation of tiles and natural stone for preferred brand(s):

Ardex                       Casco                       Deitermann

Mapei                       PCI

## Attach drawing/sketch or draw below:

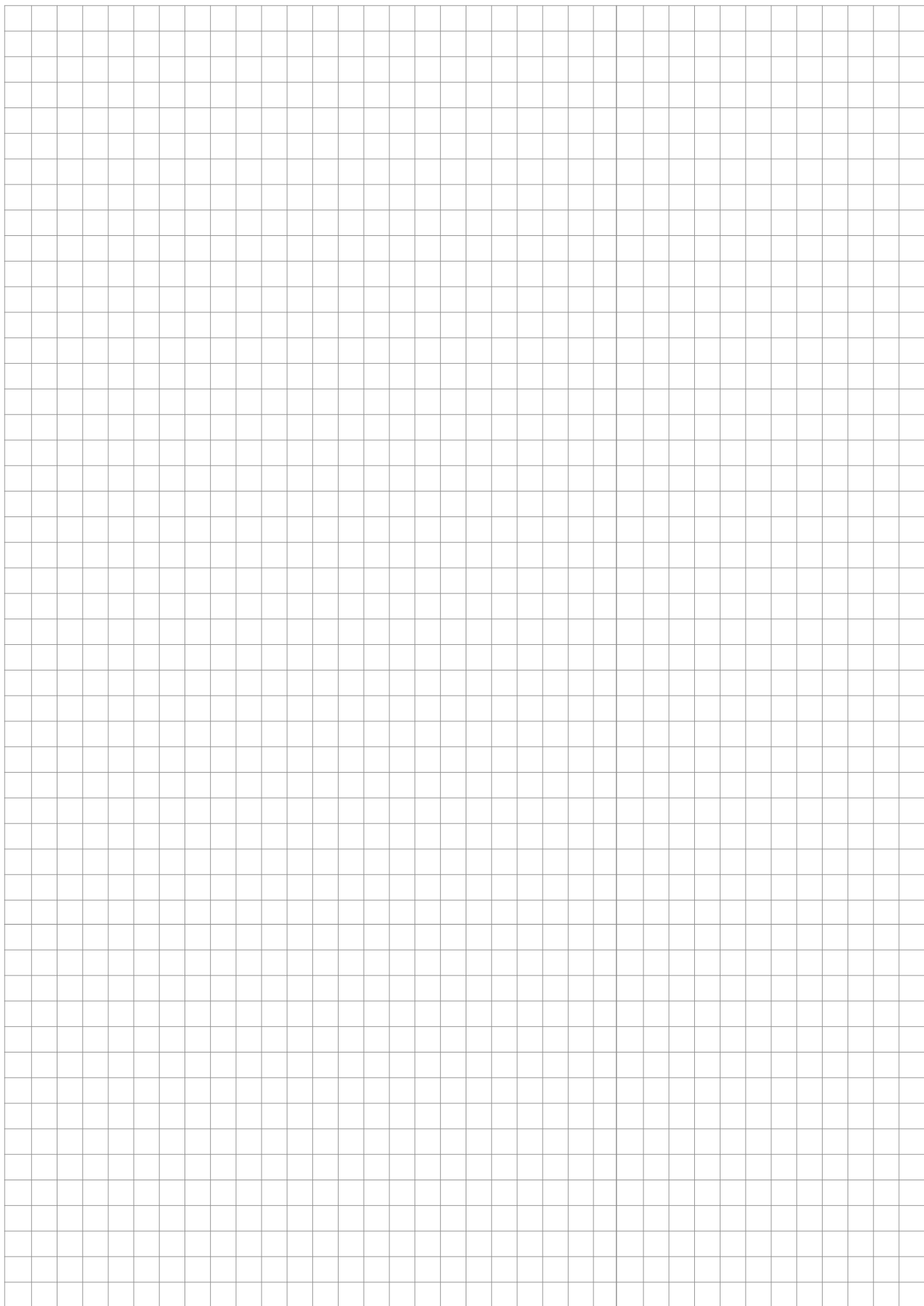

Visit us also at [www.raychemfloorheating.com](http://www.raychemfloorheating.com)  
and find out more about our other systems on  
[www.tycothermal.com](http://www.tycothermal.com)



**CE** Our products satisfy the requirements of the relevant European Directives



Member of the European Radiant Floor Heating Association e.v.

This documentation was supplied to you by:

**Raychem is a registered trademark of Tyco Thermal Controls.**

All of the above information, including illustrations, is believed to be reliable. Users however, should independently evaluate the suitability of each product for their application. Tyco Thermal Controls makes no warranties as to the accuracy or completeness of the information and disclaims any liability regarding its use. Tyco Thermal Controls only obligations are those in the Standard Terms and Conditions of Sale for this product and in no case will Tyco Thermal Controls be liable for any incidental, indirect or consequential damages arising from the sale, resale, use or misuse of the product. Tyco Thermal Controls Specifications are subject to change without notice. In addition Tyco Thermal Controls reserves the right to make changes in materials or processing, without notification to the Buyer, which do not affect compliance with any applicable specification.

**tyco**  
*Thermal Controls*

**European Headquarters**

Tyco Thermal Controls  
Staatsbaan 4A  
3210 Lubbeek  
Belgium  
Tel. 0800 969 013  
Fax 0800 968 624

**United Kingdom**

Tyco Thermal Controls (UK) Ltd  
3 Rutherford Road  
Stephenson Industrial Estate  
Washington, Tyne & Wear  
NE37 3HX, United Kingdom  
Tel. 0800 969 013  
Fax 0800 968 624